

pôle sud  
magnétique

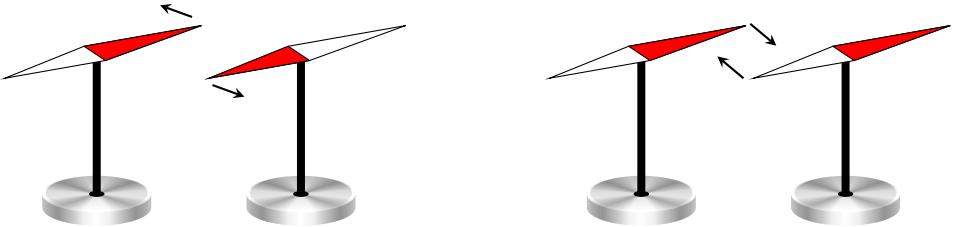

axe SN

pôle nord  
magnétique



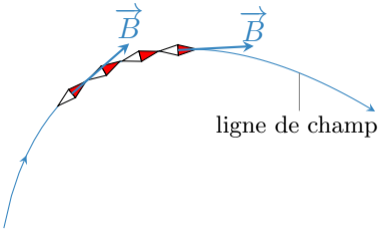

ligne de champ

canon à  
électrons

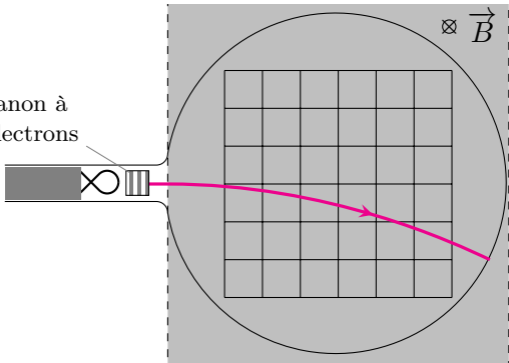

# Champ magnétique

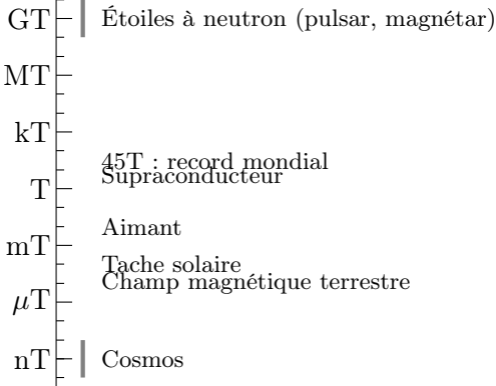

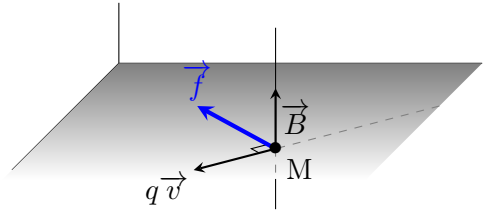

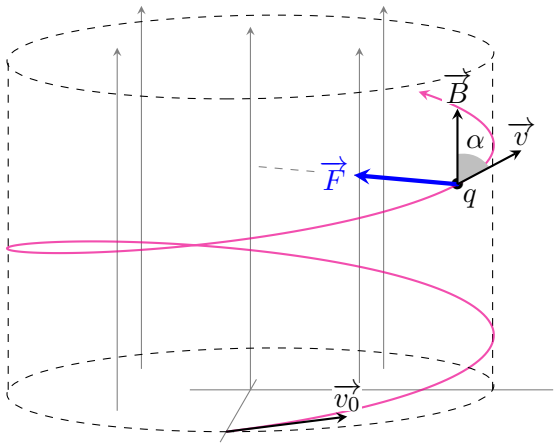

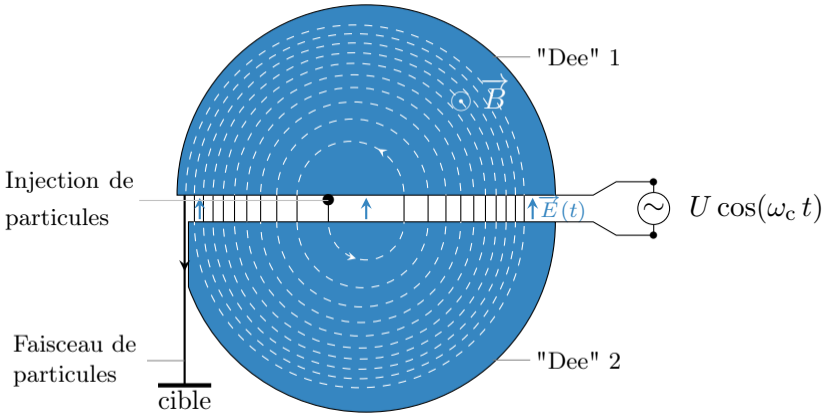



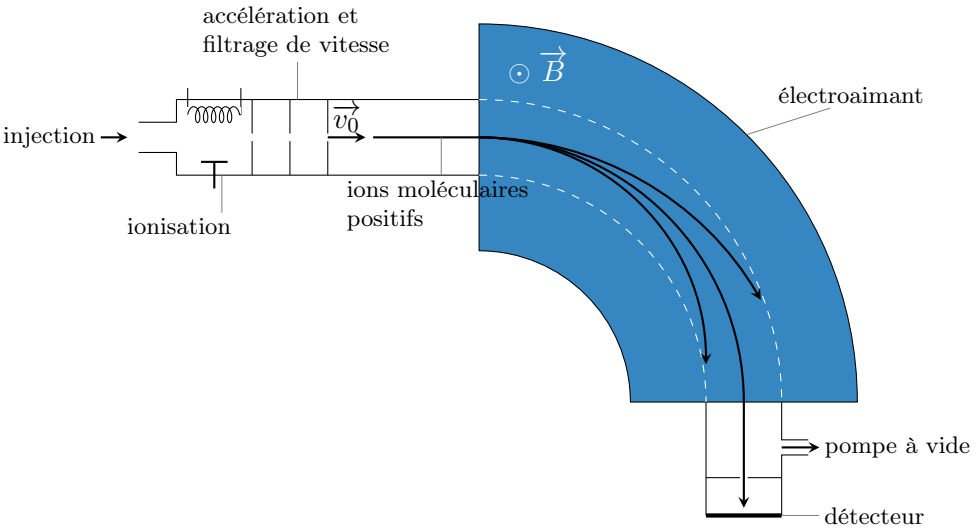

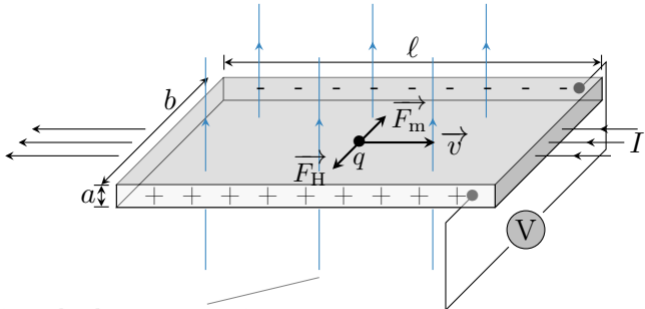

ligne de champ magnétique

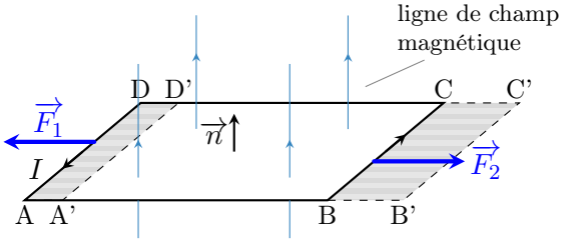

Expérience 1

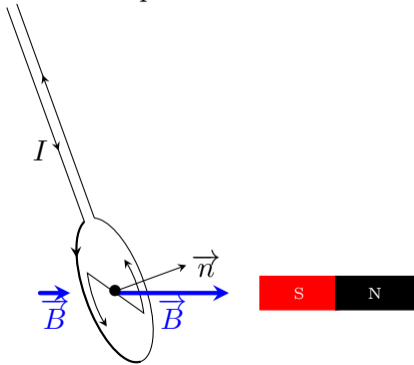

Expérience 2

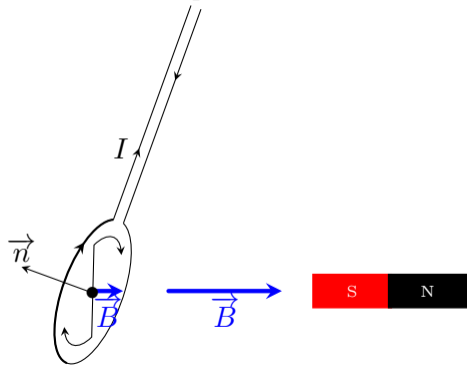

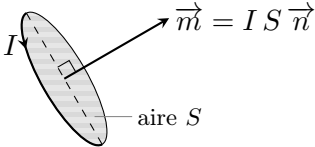

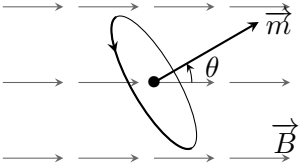

$\epsilon_p^{\text{mag}}$

$\epsilon_{\text{max}}$

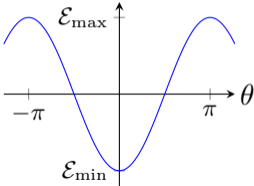

$-\pi$

$\pi$

$\epsilon_{\text{min}}$